

HNNM

MEDICAL

EMPOWERING ORTHOPEDIC INNOVATION

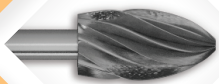

DRILLS, BLADES, AND BURS

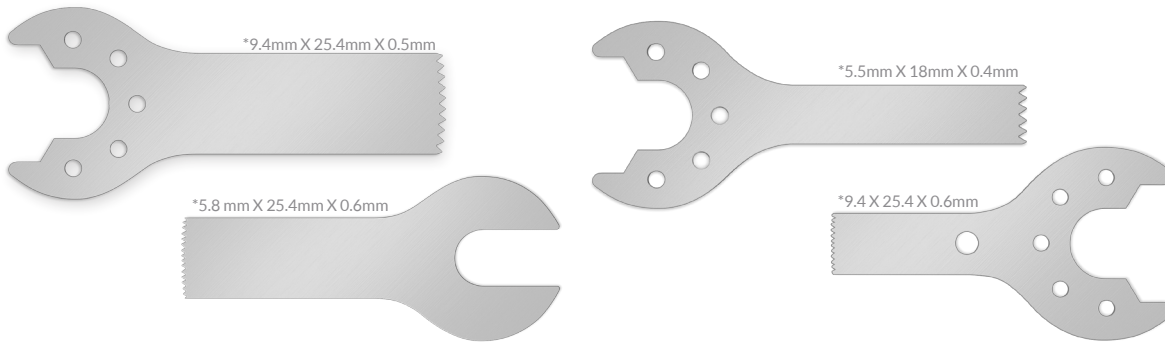

SMALL SAGITTAL SAW BLADE

ITEM #	DESCRIPTION
HNM-39-150933	SMALL SAGITTAL SAW BLADE, 9.4MM X 25.4MM X 0.5MM
HNM-39-150934	SMALL SAGITTAL SAW BLADE, 5.6MM X 25.6MM X 0.6MM
HNM-39-150935	SMALL SAGITTAL SAW BLADE, 5.5MM X 18MM X 0.4MM
HNM-39-150936	SMALL SAGITTAL SAW BLADE, FINE TOOTH, 9.4X25.4X0.6MM
HNM-39-150937	SMALL SAGITTAL SAW BLADE, COARSE TOOTH, 5.8X25.4X0.6MM

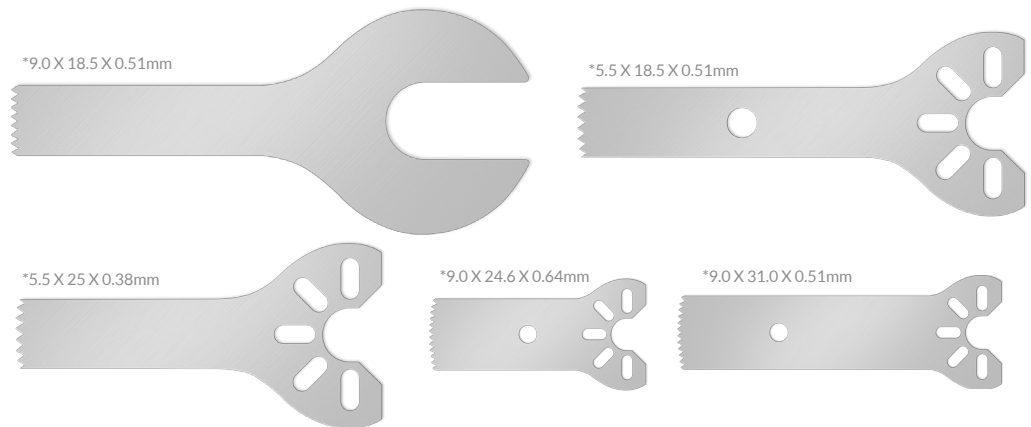

OSCILLATING BLADE

ITEM #	DESCRIPTION
HNM-39-150938	OSCILLATING BLADE 5.5X25X0.38MM
HNM-39-150939	OSCILLATING SAW BLADE 5.5X18.5X0.51MM
HNM-39-150940	OSCILLATING SAW BLADE 9.0 X 18.5 X 0.51MM
HNM-39-150941	OSCILLATING SAW BLADE 9.0X24.6X0.64MM
HNM-39-150942	OSCILLATING SAW BLADE 9.0X31.0X0.51MM

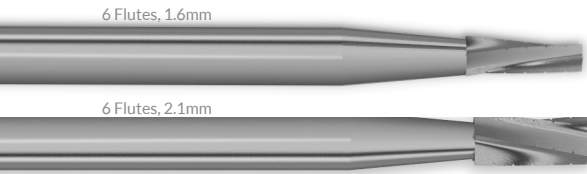

SIDE CUTTING CARBIDE BUR

ITEM #	DESCRIPTION
HNM-40-150945	SIDE CUTTING CARBIDE BUR, 6 FLUTES, 1.6MM
HNM-40-150946	SIDE CUTTING CARBIDE BUR, 6 FLUTES, 2.1MM

EGG BUR

ITEM #	DESCRIPTION
HNM-40-150947	EGG BUR, 10 FLUTES, 4.0MM
HNM-40-150953	EGG BUR, 14 FLUTES, 6.0MM
HNM-40-150954	EGG BUR, 10 FLUTES, 4.0MM

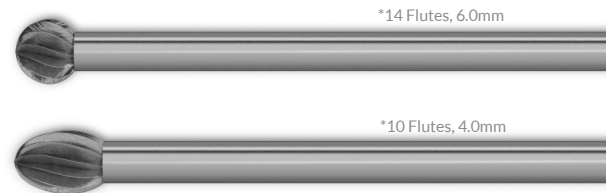

ROUND STEEL OTOLOGY BUR

ITEM #	DESCRIPTION
HNM-40-150948	ROUND STEEL OTOLOGY BUR, 6 FLUTES, 2.4MM

OVAL CUTTING CARBIDE BUR

ITEM #	DESCRIPTION
HNM-40-150949	OVAL CUTTING CARBIDE BUR, 5.5MM
HNM-40-150950	OVAL CUTTING CARBIDE BUR, 4.0MM

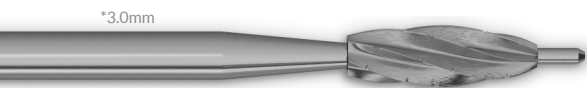
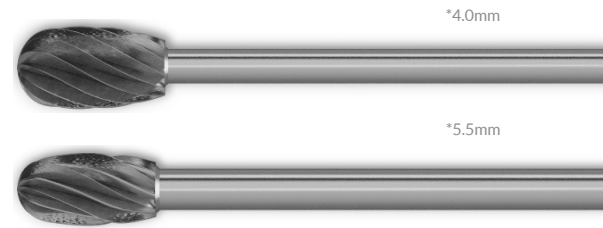

ROUND CUTTING CARBIDE BUR

ITEM #	DESCRIPTION
HNM-40-150951	ROUND CUTTING CARBIDE BUR, 3.0MM

SWANSON PILOT POINT BUR

ITEM #	DESCRIPTION
HNM-40-150952	SWANSON PILOT POINT BUR, 5 FLUTES, 3.0MM



ROUND BUR

ITEM #	DESCRIPTION
HNM-40-150955	ROUND BUR, 12 FLUTES, 4.0MM

DRILLS, BLADES, AND BURS

SMALL TEAR CROSS CUT RASP

ITEM #	DESCRIPTION
HNM-40-150955	SMALL TEAR CROSS CUT RASP, 11MM X 5MM - LIKE STRYKER 5100-37-113

STANDARD JACOBS TWIST DRILL

ITEM #	DESCRIPTION
HNM-41-150957	STANDARD JACOBS TWIST DRILL 2.0MM X 127MM
HNM-41-150958	STANDARD JACOBS TWIST DRILL 3.2MM X 127MM

STANDARD TWIST DRILLS

Item #	Description
HNM-41-150968	STANDARD TWIST DRILL 1.6X127MM
HNM-41-150969	STANDARD TWIST DRILL 2.0X127MM
HNM-41-150970	STANDARD TWIST DRILL 2.4X127MM
HNM-41-150971	STANDARD TWIST DRILL 2.8X127MM
HNM-41-150972	STANDARD TWIST DRILL 3.2X127MM
HNM-41-150973	STANDARD TWIST DRILL 3.6X127MM

TWIST DRILLS

Item #	Description
HNM-41-150974	TWIST DRILL, 3.2X130MM
HNM-41-150975	TWIST DRILL, 3.5X95MM
HNM-41-150976	TWIST DRILL, 4.0X127MM
HNM-41-150977	TWIST DRILL 4.5X127MM
HNM-41-150978	TWIST DRILL 4.8X127MM
HNM-41-150979	TWIST DRILL 6.4X127MM

TWIST DRILLS STANDARD WITH 2.34MM SHANK

Item #	Description
HNM-41-150959	TWIST DRILL STANDARD WITH 2.34MM SHANK, 1.1X4.9MM
HNM-41-150960	TWIST DRILL STANDARD WITH 2.34MM SHANK, 1.3X4.9MM
HNM-41-150961	TWIST DRILL STANDARD WITH 2.34MM SHANK, 1.5X4.9MM
HNM-41-150962	TWIST DRILL STANDARD WITH 2.34MM SHANK, 1.8X4.9MM
HNM-41-150963	TWIST DRILL STANDARD WITH 2.34MM SHANK, 2.0X65MM
HNM-41-150964	TWIST DRILL STANDARD WITH 2.34MM SHANK, 2.2X49MM
HNM-41-150965	TWIST DRILL STANDARD WITH 2.34MM SHANK, 2.7X79MM
HNM-41-150966	TWIST DRILL STANDARD WITH 2.34MM SHANK, 3.2X79MM
HNM-41-150967	TWIST DRILL STANDARD WITH 2.34MM SHANK, 3.5X79MM

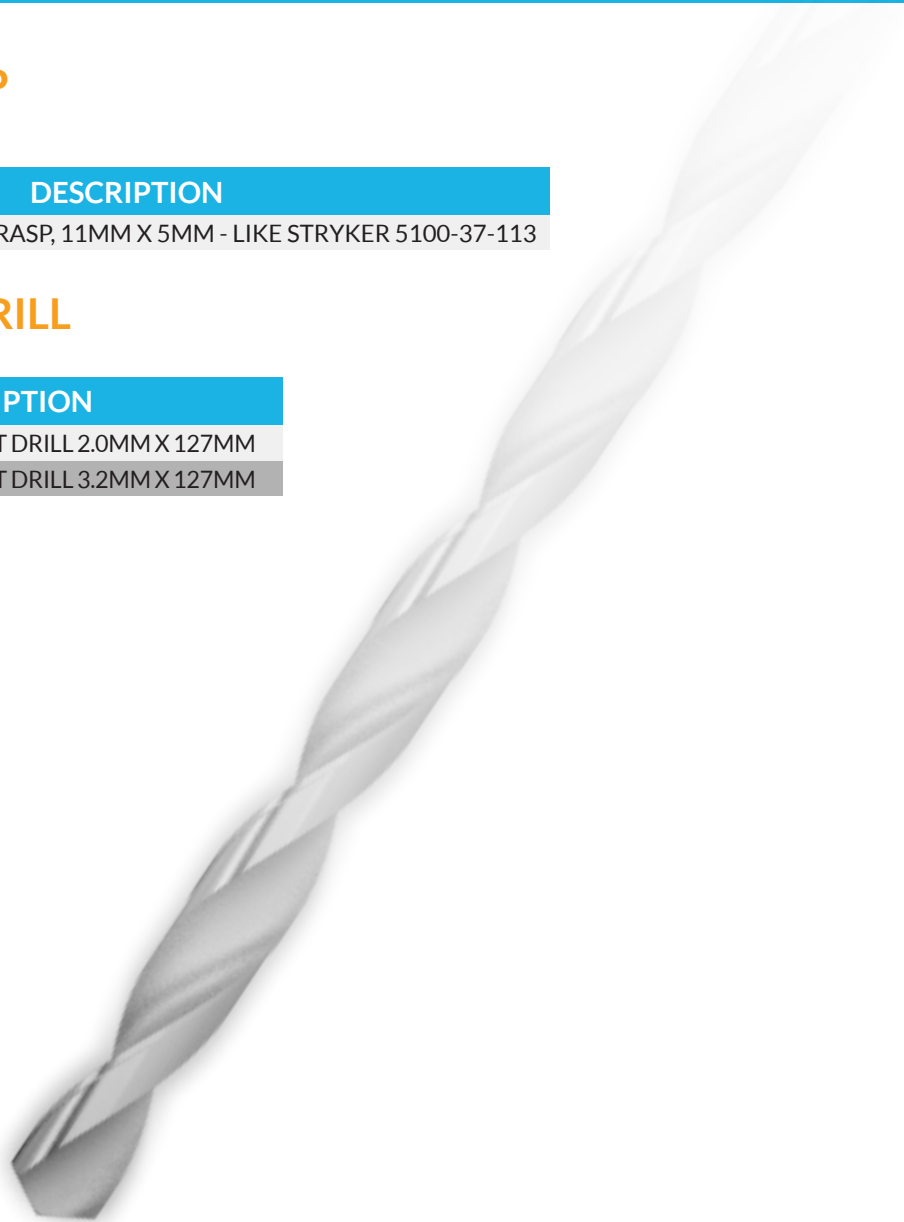

HNM **MEDICAL**

➤ 20855 NE 16 Ave Suite C15, Miami, FL 33179

☎ 1.866.291.8498
📞 1.888.608.9788

✉ sales@hnmmedical.com
🌐 www.hnmmedical.com